









SL-OVA-1200

INFORMACIÓN TÉCNICA

SINGLE LIFT

Dimensión	 LxWxH	2365 x 1678 x 600 mm
Número de almohadillas		4+4
Peso		250 kg ± 10
Sistema eléctrico		24 V / 220 V
Diámetro de la almohadilla		450 mm
Máx. Carga de trabajo		1200 kg
Ángulo de inclinación automático		0°/90°
Ángulo de giro automático		360°

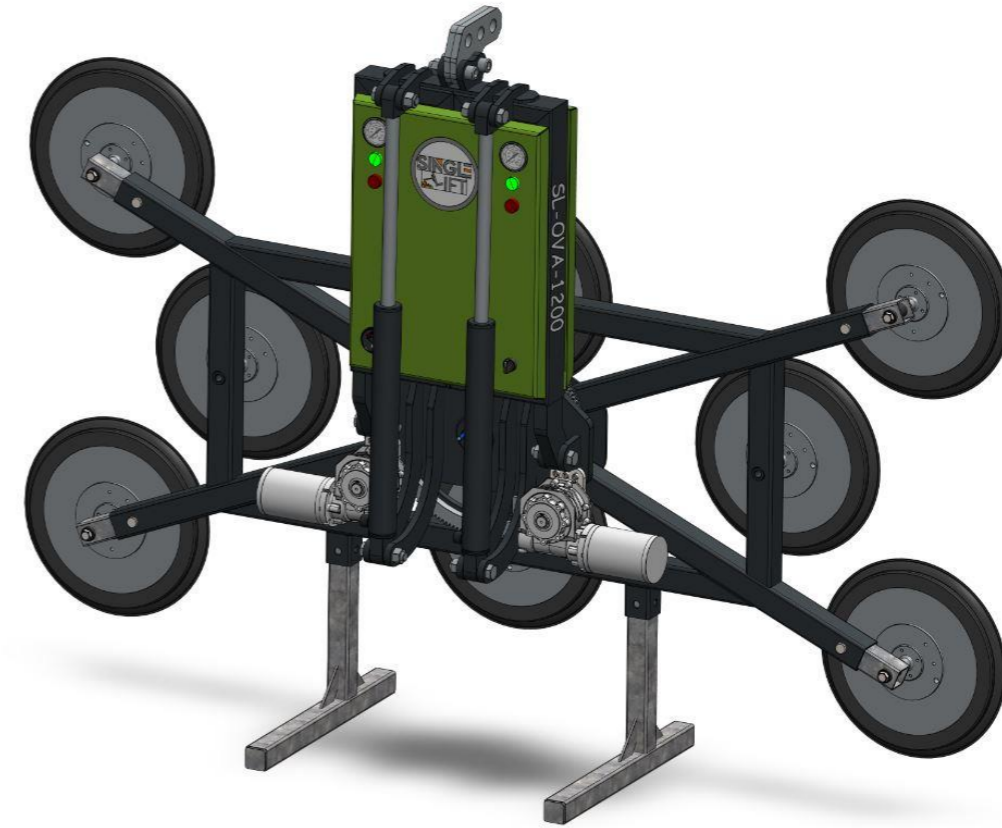

Control Remoto
Inalámbrico

SINGLE LIFT
SINGLELIFT LOTS OF WORK

www.singlelift.com

